

QK-A034-B Manual

Bi-Directional Multiplexer

NMEA 2000 - NMEA 0183 - WiFi - USB

with NMEA 0183 and SeaTalk¹ input options



Designed in UK



Features

- Bi-directional WiFi
- Bi-directional NMEA 2000
- Bi-directional NMEA 0183
- Bi-directional USB
- Combines input data from three NMEA 0183 input devices, and one SeaTalk input
- Galvanically isolated NMEA 0183 and SeaTalk ports (also called opto-isolation, Galvanic isolation prevents unwanted currents between devices, preventing equipment damage and interference with radio signals)
- SeaTalk¹ Converter (Converts commonly used SeaTalk¹ data types to NMEA 0183 sentences)
- NMEA 0183 to NMEA 2000 converter (converts common NMEA 0183 sentences to PGNs)
- NMEA 2000 to NMEA 0183 converter (converts common NMEA 2000 PGNs into NMEA 0183 sentences)
- WiFi: Ad-hoc mode allows up to 4 connections to the internal WiFi module simultaneously
- WiFi: Station mode allows for the connection of the A034-B to your router/ access point for greater number of wireless users and WiFi range
- WiFi: Standby option(disable WiFi)
- WiFi and USB input and output of combined data in NMEA 0183 sentence format
- WiFi and USB additionally output of NMEA 2000 network PGNs (in both 0183 sentences and PCDIN format)
- Compatible with Windows, Mac, Linux
- Compatible with Android and iOS via WiFi
- Filtering allows for overflow reduction and additional configuration
- Routing reduces the risk of data over-flow

Contents

1.	Introduction	3
2.	Mounting	4
3.	Connections	5
3.1.	Status LEDs.....	6
3.2.	NMEA 0183 Inputs	6
3.3.	NMEA 0183 wiring - RS422 or RS232?	7
3.4.	SeaTalk1 Input	7
3.5.	NMEA 2000 Port.....	8
3.6.	Conversion Lists	8
3.6.1.	NMEA 0183 to NMEA 2000 conversions	9
3.6.2.	NMEA 2000 to NMEA 0183 conversions	9
3.7.	WiFi Output.....	10
3.7.1.	WiFi Ad-hoc mode connection.....	11
3.8.	USB Output.....	11
3.8.1.	Will a driver be needed to connect via USB?	11
3.8.2.	Checking the USB connection (Windows).....	12
3.9.	NMEA 0183 output	12
4.	Configuration (via USB)	13
4.1.	Configuring Baud Rates	13
4.2.	WiFi - Station mode	14
4.3.	WiFi – Standby/Disable	14
4.4.	Filtering	15
4.4.1.	Configuring filters.....	15
4.4.2.	Routing data away from chosen outputs	15
4.5.	USB - Monitoring NMEA Messages	16
5.	Upgrading firmware.....	16
6.	Specification.....	16
7.	Limited Warranty and Notices.....	17
8.	Disclaimer	17
9.	Document History	17

1. Introduction

The QK-A034-B is a sophisticated bi-directional NMEA 2000, WiFi, USB and NMEA 0183 multiplexer, with a huge amount of flexibility for your growing system.

It is the perfect solution for merging wired NMEA2000 and NMEA 0183 equipment to each other and to USB laptops and tablet WiFi APPs to form a linked-up system.

The A034-B multiplexer has three NMEA 0183 inputs (listener-ports), one SeaTalk¹ input, a bi-directional NMEA 2000 output port, NMEA 0183 output, bi-directional WiFi and bi-directional USB port.

INPUTS (listener ports)	OUTPUTS (talker ports)
NMEA 2000	NMEA 2000
WiFi	WiFi
USB	USB
3 x NMEA 0183	NMEA 0183
1 x SeaTalk ¹	

All NMEA 2000, NMEA 0183, USB and WiFi devices can communicate with each other.

In addition to bi-directional NMEA 2000, WiFi, USB and NMEA 0183, the A034-B provides a connection to Raymarine SeaTalk¹ input devices to all connected output devices (NMEA 2000, NMEA 0183, WiFi and USB devices). Specifically, the internal SeaTalk¹ converter allows the A034-B to listen on the SeaTalk¹ bus and convert SeaTalk¹ data to NMEA 0183, which are in turn converted to NMEA 2000 PNGs.

The A034-B can be used out of the box for standard functionality or configured for additional sophistication. Through advanced filtering and routing options, the A034-B allows controlled filtering of data input, blocking of unwanted data and routing for data management and overflow reduction.

Default Standard Functionality: The multiplexer converts and combines data received on all inputs and listeners ports and sends this data to NMEA 2000 output port, NMEA 0183, USB output and WiFi interface.

- **Bi-directional WiFi:** With 2-way WiFi connectivity, the A034-B allows for wireless connection to autopilots and other NMEA devices if desired. Data from instruments is available wirelessly through WiFi connections, giving complete freedom to navigate, monitor and control from anywhere on board. Up to 4 connections from iPads, iPhone, Android phones and tablets or other WiFi enabled devices can connect directly to the A034-B with no need for a WiFi access point. (Thought it can also be connected to an access point/router if desired (see WiFi section))
- **Bi-directional USB:** The USB port also supports bi-directional communications. It allows computer-based, navigation applications to send sentences through the multiplexer to control an autopilot and other devices. The USB port is also used for configuration of specific WiFi and NMEA ports settings.

Additional Configurable Functionality (through Windows software via USB):

- **Additional WiFi options** including connection to an access point to share marine data across your entire WiFi network or disabling WiFi output if desired.
- **Filtering options:** Each input also has a flexible filter that can be configured to pass or block specific sentences. This frees up bandwidth, significantly reducing the possibility of data overflow and resulting loss of data.
- **Routing options:** the powerful routing feature allows the NMEA, SeaTalk and WiFi input data to be routed from any input to specific outputs.

2. Mounting

The A034-B was designed for the small-commercial, leisure and fishing boat and vessel monitoring markets. Although the A034-B case is water resistant, the terminals are open and seawater can cause a short circuit.

The A034-B comes with an extruded aluminium enclosure with external dimensions of 114.5 x 110 x 32 mm.

The A034-B should be mounted in a dry place such as behind the instrument panel on a flat surface. Ensure there is enough space around the multiplexer to connect the wirings.

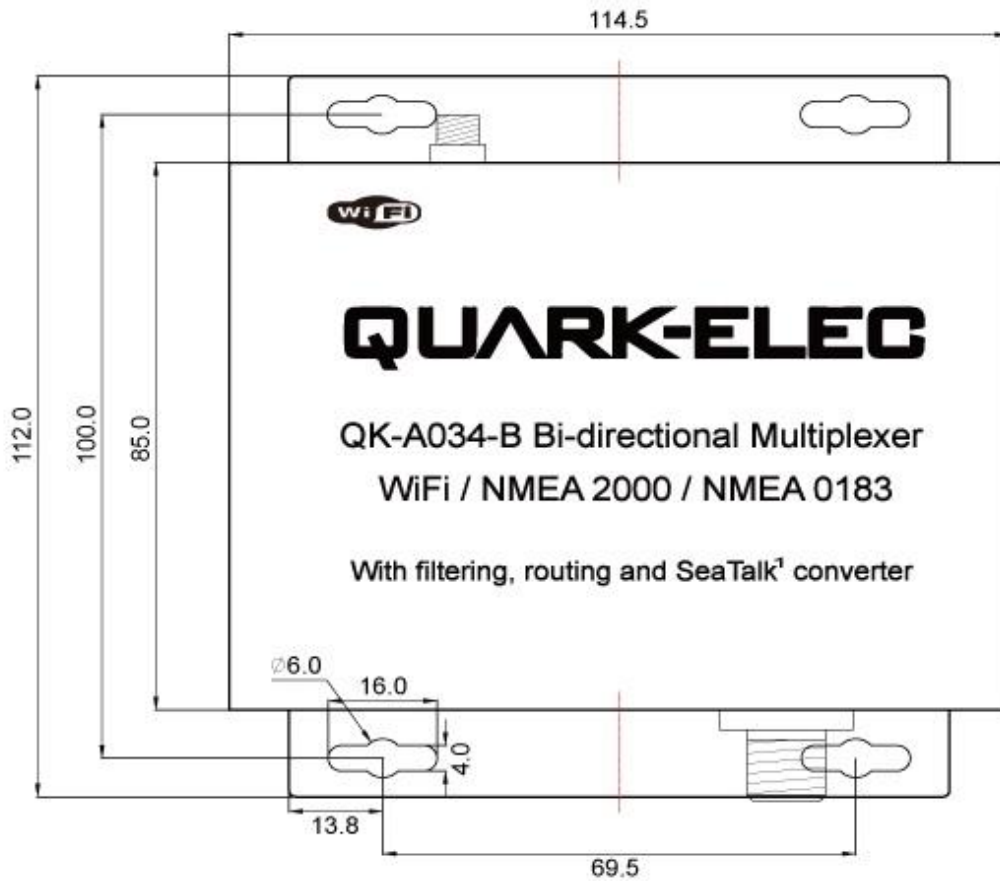

Figure 1Dimensions

3. Connections

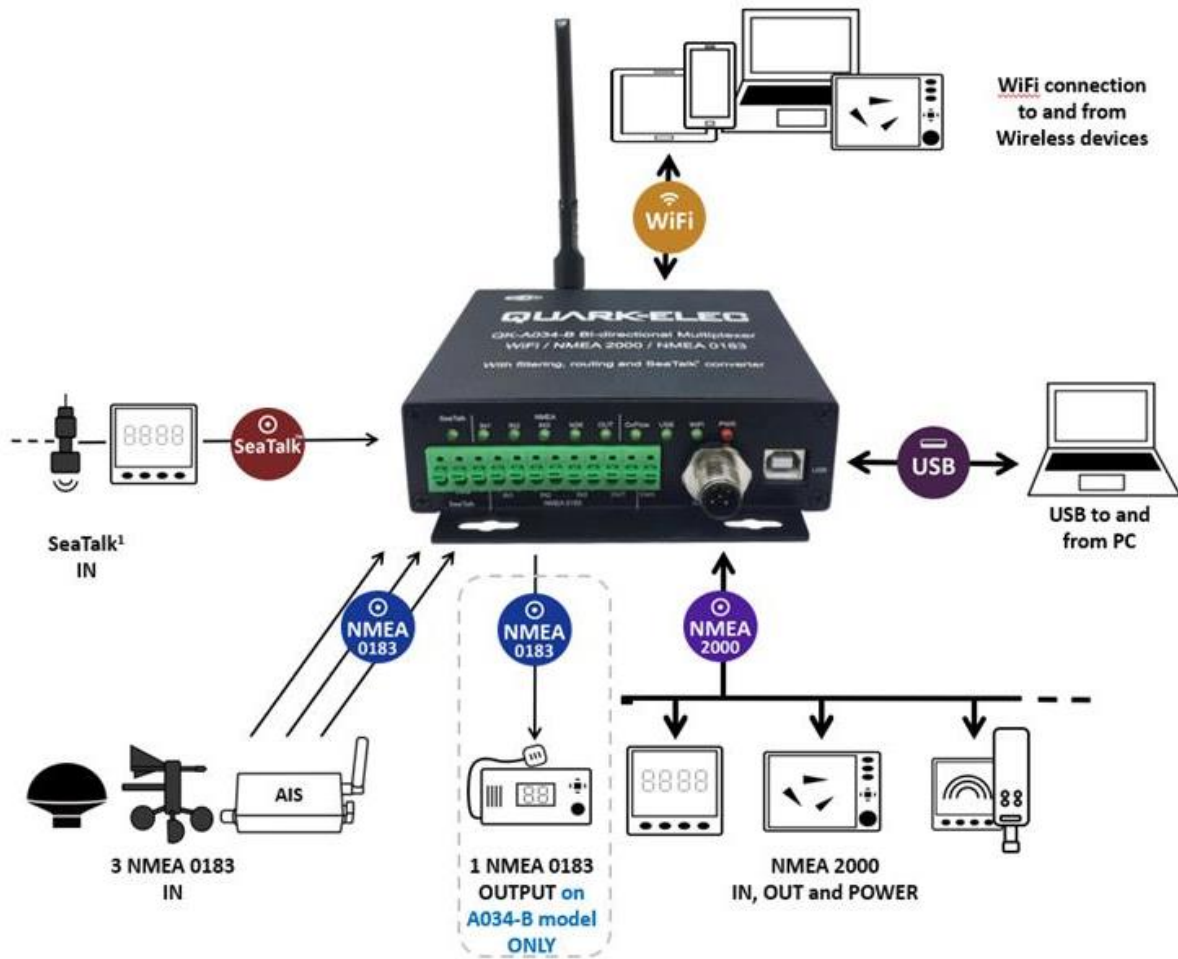

Figure 2: Typical system connection

The A034-B multiplexer has the following options for connection to inputs, outputs and host devices.

- NMEA 2000 connection for power, data input and output
- 3x NMEA 0183 inputs
- 1x NMEA 0183 output
- 1x SeaTalk¹ input
- USB connection for data input and output
- WiFi antenna for data input and output

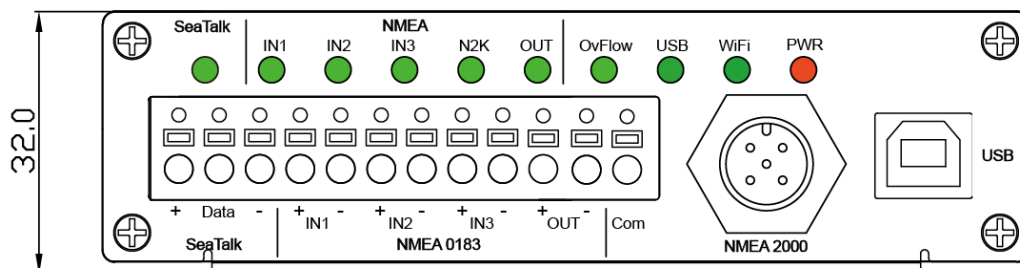

Figure 1: Side view drawing



Power OFF all the devices before connecting!

3.1. Status LEDs

A034-B features ten LEDs which indicate SeaTalk¹ in, NMEA IN, IN2, IN3, NMEA2000 Output, NMEA 0183 output, Overflow, USB, WIFI and Power status respectively.

The status LEDs on the panel show port activity and system status.

- **SeaTalk¹ and NMEA IN1/2/3:** LEDs will flash for each valid message received.
- **N2K:** LED will flash for each valid NMEA 2000 PGN sent out on NMEA 2000 port.
- **OUT (NMEA 0183 output):** LED will flash for each valid message send out.
- **Overflow:** LED will flash if the NMEA 0183 output experiences data overflow due to an excessive queue, above the buffer allowance (data lost)
- **USB:** LED will flash for each valid NMEA message sent to USB output.
- **WiFi:** LED will flash for each valid NMEA message sent to WiFi output.
- **PWR (Power):** LED light is constantly lit in red when the device is powered.

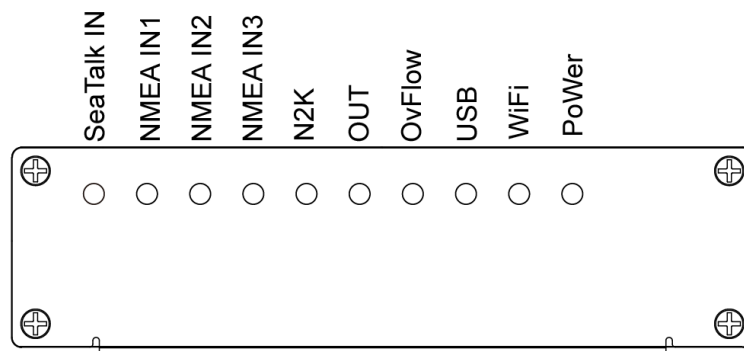

Figure 2: LED indications

3.2. NMEA 0183 Inputs

A034-B has three NMEA inputs called IN1, IN2 and IN3. Each input should be connected to one device only.

Every NMEA 0183 input and output is galvanically isolated (also called opto-isolation) as specified by the NMEA standard. A galvanically isolated input prevents unwanted currents flowing between the instruments and the multiplexer, protecting devices from equipment damage and reducing interference with radio signals.

Each input has an internal filter which can be configured to pass or block specific sentences from the input devices (See the Configuration section). The A034-B combines these filtered NMEA 0183 inputs with the NMEA sentences converted from the SeaTalk¹ and other inputs into one NMEA0183 serial data stream.

NMEA baud rates are set to the following default settings:

- NMEA IN 1: 4800 bps
- NMEA IN 2: 4800 bps
- NMEA IN 3: 38400bps

These can be adjusted as required, using the Configuration software (see the Configuration section).

Regarding connection to external NMEA devices: Although the NMEA 0183 standard specifies signal names, voltage levels and connection methods clearly; in reality, this standard has been interpreted with variation between manufacturers. To ensure the A034-B is not damaged please double-check the specifications of all devices before connecting them.

Please note:

The A034-B NMEA 0183 connectors use the RS422 (differential) protocol.



Connect the + and - terminals of the NMEA input on the A034-B, to the + and - terminals of the output on the instrument (e.g., wind / depth / heading sensor). These instrument terminals may also be labelled A/B, Data+/Data-, RX+/RX-, In+/In-.



If your connecting device uses the older RS232 (single-ended) protocol, you can still connect to the A034-B; you may simply need a QK-AS03 Protocol Bridge for your connection. (<https://www.quark-elec.com/product/qk-as03-nmea-protocol-bridge/>).

3.3. NMEA 0183 wiring - RS422 or RS232?

A034-B uses the NMEA 0183-RS422 protocol (differential signal), however some chart plotters or devices may use the older NMEA 0183-RS232 protocol (single-ended signal).

Check which protocol your connecting NMEA devices (e.g. Chart plotter) use. If you are unsure whether your connecting NMEA 0183 device uses NMEA 0183 RS422 or RS232, the input/output connections on the device will give you some indication. Unfortunately, manufacturers who use the older RS232 protocol are not consistent in their product labelling. The following table may help you identify which protocol your product uses, however always check the manual to be certain. If your connecting device uses the older RS232 protocol, use a QK-AS03 Protocol Bridge. The QK-AS03 connects and converts RS422 to the older RS232 and vice versa, through a simple connection, no configuration needed.

RS422 (Differential)	RS232 (single-ended)
TX+ and TX- / RX+ and RX-	TX+ and TX- (GND) / RX+ and RX- (GND)
	TXa+ and TXa- (GND) / RXa+ and RXa- (GND)
	Output +Ve and -Ve / Input +Ve and -Ve
	Occasionally older NMEA 0183 RS232 devices are labelled like RS422 (TX+ and TX- / RX+ and RX-) so check the product manuals.

3.4. SeaTalk¹ Input

The built-in SeaTalk¹ to NMEA converter translates SeaTalk data into NMEA sentences. The SeaTalk port has 3-Pin terminals for connection to the SeaTalk bus. Ensure the connection is correct before powering up. An inaccurate connection could damage the A034-B and other devices on the SeaTalk Bus.

The SeaTalk converter converts the SeaTalk messages in the conversion table below. When a SeaTalk message is received, A034-B checks if the message is supported. When the message is recognized as being supported, the message is extracted, stored and converted to an NMEA sentence. Any unsupported datagrams are ignored. These converted NMEA messages are filtered and then combined with NMEA data received on the other inputs.

This function allows the NMEA multiplexer to listen on the SeaTalk bus. Only one SeaTalk input is needed as the SeaTalk bus is a single-cable system that connects all instruments. The A034-B SeaTalk to NMEA converter works in one direction only. NMEA sentences are not converted to SeaTalk.

Supported SeaTalk ¹ Datagrams		
SeaTalk ¹	NMEA	Description
00	DBT	Depth below transducer
10	MWV	Wind angle, (10 and 11 combined)
11	MWV	Wind speed, (10 and 11 combined)
20	VHW	Speed through water, includes heading when present
21	VLW	Trip mileage (21 and 22 combined)
22	VLW	Total mileage (21 and 22 combined)
23	MTW	Water temperature
25	VLW	Total and Trip mileage
26	VHW	Speed through water, includes heading when present
27	MTW	Water temperature
50	---	GPS latitude, value stored
51	---	GPS longitude, value stored

52	---	GPS speed over ground, value stored
53	RMC	Course over ground. RMC sentence is generated from stored values from other GPS related datagrams.
54	---	GPS time, value stored
56	---	GPS date, value stored
58	---	GPS lat/long, values stored
89	HDG	Magnetic heading, including variation (99)
99	---	Magnetic variation, value stored

As the table shows, not all datagrams result in an NMEA 0183 sentence. Some datagrams are only used to retrieve data, which is combined with other datagrams to create one NMEA 0183 sentence.

3.5. NMEA 2000 Port

The A034-B converter provides a NMEA 2000 network connection. The A034-B combines all the NMEA 0183 data inputs and then converts them to be NMEA 2000 PGNs and vice-versa. With A034-B, WiFi data, USB data and NMEA 0183 input and SeaTalk¹ input data can be available on new NMEA 2000 capable instruments, such as NMEA 2000 chart plotters.

- The A034-B requires power from a NMEA 2000 backbone.
- NMEA 2000 network must at least consist of, a powered backbone with two terminators (termination resistors), to which the multiplexer and any other NMEA 2000 devices must be connected.

Each NMEA 2000 device connects to the backbone. It is not possible to simply connect two NMEA 2000 devices directly together.

The A034-B is supplied with a spurred five-core screened cable for the NMEA 2000 connection, fitted with a male micro-fit connector. Simply connect the cable to the network backbone.

3.6. Conversion Lists

The conversion tables on the following pages list the supported NMEA 2000 PGN's (parameter group numbers) and NMEA 0183 sentences. It is important to check the tables to confirm that the A034-B will convert the sentences/PGNs required.

Through USB and WiFi the A034-B will output in NMEA 0183 format, including all NMEA 0183 messages received and NMEA 0183 messages converted from the NMEA 2000 network.

WiFi/USB inputs are NMEA 0183 messages and are converted to NMEA 2000 for the NMEA 2000 bus.

The following is a typical PCDIN message format outputted through WiFi and USB. The chart software will convert this into more meaningful information.

---Received message: \$PCDIN, 01F119, 00000000, 16,0064050800FFFF0C*5B---

Header	PGN	Time Stamp	Source ID	Data	Termination	Check Sum
\$PCDIN	01F119	00000000	16	0064050800FFFF0C	*	5B

3.6.1. NMEA 0183 to NMEA 2000 conversions

The following NMEA 0183 to NMEA 2000 conversions are currently supported.

NMEA 0183 sentence	Function	Converted to NMEA 2000 PGN/s
DBT	Depth Below Transducer	128267
DPT	Depth	128267
GGA	Global Positioning System Fix Data	126992, 129025, 129029
GLL	Geographic Position Latitude/Longitude	126992, 129025
GSA	GNSS DOP and Active Satellites	129539
GSV	GNSS Satellites in View	129540
HDG	Heading, Deviation & Variation	127250
HDM	Heading, Magnetic	127250
HDT	Heading, True	127250
MTW	Water Temperature	130311
MWD	Wind Direction & Speed	130306
MWV	Wind Speed and Angle (True or relative)	130306
RMB	Recommended Minimum Navigation Information	129283,129284
RMC*	Recommended Minimum Specific GNSS Data	126992, 127258, 129025, 12902
ROT	Rate Of Turn	127251
RPM	Revolutions	127488
RSA	Rudder Sensor Angle	127245
VHW	Water Speed and Heading	127250, 128259
VLW	Dual Ground/Water Distance	128275
VTG*	Course Over Ground and Ground Speed	129026
VWR	Relative (Apparent) Wind Speed and Angle	130306
XTE	Cross Track Error, Measured	129283
ZDA	Time & Date	126992
VDM	AIS Message 1,2,3	129038
VDM	AIS Message 4	129793
VDM	AIS Message 5	129794
VDM	AIS Message 9	129798
VDM	AIS Message 14	129802
VDM	AIS Message 18	129039
VDM	AIS Message 19	129040
VDM	AIS Message 21	129041
VDM	AIS Message 24	129809. 129810

Please note: some PGN sentences that are received require additional data before being sent.

3.6.2. NMEA 2000 to NMEA 0183 conversions

The following NMEA 2000 to NMEA 0183 conversions are currently supported.

NMEA 2000 PGN	HEX code	Function	Converted to NMEA 0183 Sentences
126992	1F010	System Time	ZDA
127245	1F10D	Rudder	RSA
127250	1F112	Vessel Heading	HDG, VHW
127251	1F113	Rate of Turn	ROT
127258	1F11A	Magnetic Variation	HDG
128259	1F503	Speed, Water referenced	VHW
128267	1F50B	Water Depth	DBT, DPT
128275	1F513	Distance Log	VLW

129025	1F801	Position, Rapid Update	GLL								
129026	1F802	COG & SOG, Rapid Update	VTG								
129029	1F805	GNSS Position Data	GGA, GLL, GSA, RMC, ZDA								
129033	1F809	Time & Date	ZDA								
129044	1F814	Datum	DTM								
129283	1F903	Cross Track Error	APB, RMB, XTE								
129284	1F904	Navigation Data	RMB								
129291	1F90B	Set & Drift, Rapid Update	VDR								
129539	1FA03	GNSS DOPs	GSA								
129540	1FA04	GNSS Sats in View	GSV								
130306	1FD02	Wind Data	MWV								
130310	1FD06	Environmental Parameters	MDA, MTW								
130311	1FD07	Environmental Parameters	MDA								
130312	1FD08	Temperature	MDA, MTW								
129038	1F80E	AIS Message 1,2,3	VDM								
129793	1FB01	AIS Message 4	VDM								
129794	1FB02	AIS Message 5	VDM								
129798	1FB06	AIS Message 9	VDM								
129039	1F80F	AIS Message 18	VDM								
129040	1F810	AIS Message 19	VDM </tr <tr> <td>129809</td> <td>1FB11</td> <td>AIS Message 24 (Part A)</td> <td>VDM</td> </tr> <tr> <td>129810</td> <td>1FB12</td> <td>AIS Message 24 (Part B)</td> <td>VDM</td> </tr>	129809	1FB11	AIS Message 24 (Part A)	VDM	129810	1FB12	AIS Message 24 (Part B)	VDM
129809	1FB11	AIS Message 24 (Part A)	VDM								
129810	1FB12	AIS Message 24 (Part B)	VDM								

Please note: some PGN sentences that are received require additional data before being sent.

3.7. WiFi Output

The A034-B allows users to send and view data through WiFi on a PC, tablet, smartphone or other WiFi enabled device. Users can access marine network data including vessel course, speed, position, wind speed, direction, water depth, AIS etc which can be viewed via the chosen chart software. The IEEE 802.11b/g wireless standard has two basic modes of operation; Ad-hoc mode (peer to peer) and station mode (also called infrastructure mode). The A034-B supports 3 modes.

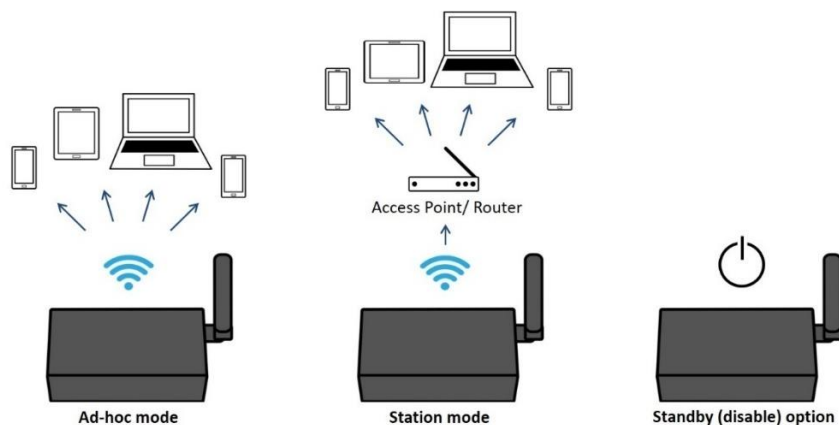

- In **Ad-hoc mode (default)**, wireless devices connect directly (peer to peer) without a router or access point. For example, your Smartphone can connect directly to the A034-B to receive marine data. The A034-B is set to Ad-hoc mode as a default setting, but can be easily setup to station mode or standby mode through the configuration tool. (See Configuration section)
- In **Station mode**, wireless devices communicate through an access point (AP) such as a router that serves as a bridge to other networks (such as the Internet or LAN). This allows your router to handle the data and traffic from your device. This data can then be picked up through your router anywhere on your local area network. Increasing the WiFi range. Similar to plugging the device directly into the router, but using wireless technology. In this way, the mobile devices receive both your marine data and other AP connections such as Internet.
- WiFi can also be disabled in **Standby mode**. This reduces power consumption and may be required when connecting 2 WiFi transmitting devices.

3.7.1. WiFi Ad-hoc mode connection

From a Phone, Tablet or PC: Once the A034-B has powered up, scan for a WiFi network with an SSID of 'QK-A034-B xxxx' or similar.

Connect to 'QK-A034-B xxxx' with the default password: '88888888'.

A034-B SSID	Similar to 'QK-A034-B xxxx'
WiFi password	88888888

In the chart software (or chart plotter), Set the protocol to 'TCP', IP address to '192.168.1.100' and the port number to '2000'.

Protocol	TCP
IP address	192.168.1.100
Data Port	2000

With the above settings, a wireless connection is established and the user will receive the data through the chart software.

Note: In Ad-hoc mode, the IP address should not be changed. The SSID and password can be changed. The password must be 8 to 12 characters long.

The wireless connection and data flow can be checked with TCP/IP port monitoring software as shown. (Image: TCP/IP Net Assistant shown as example)

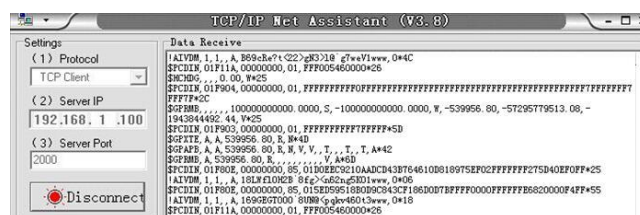

For Station mode WiFi or to disable the WiFi function, see the Configuration section.

3.8. USB Output

The A034-B is supplied with a type B USB connector and USB cable. The USB cable can be linked directly to a USB port on the PC.

The USB connector provides data input and output as standard (multiplexed information from all input instruments will be sent to this connection). The USB port is also used to configure the multiplexer and to update its firmware.

3.8.1. Will a driver be needed to connect via USB?

To enable the USB data connection of A034-B to other devices, related hardware drivers may be needed dependent on your system requirements.

Mac:

No driver required. For Mac OS X, the A034-B will be recognized and shown as a USB modem. The ID can be checked with the following steps:

1. Plug the A03 into a USB port and launch Terminal.app.
2. Type: `less /dev/*sub*`
3. The Mac system will return a list of USB devices. A034-B will display as - `"/dev/tty.usbmodemXYZ"` where XYZ is a number. Nothing further needs to be done if it is listed.

Linux:

No driver required. When plugged into the computer, A034-B will show up as a USB CDC device on `/dev/ttyACM0`.

Windows 7,8,10:

The drivers usually install automatically if your device is running an original Windows 10 version. A new COM port will automatically show up in the device manager once powered and connected via USB.

The A034-B registers itself to the computer as a virtual serial com port.

If the driver does not install automatically, it can be found on the included CD and downloaded from www.quark-elec.com.

3.8.2. Checking the USB connection (Windows)

After the driver is installed (if needed), run the Device Manager and check the **COM number** (this is the number associated with the USB port you are using. The port number is the number that Windows assigns as an input device. These can be generated randomly by your computer). Your chart software may require your COM number in order to access the data.

The port number for the A034-B can be found in Windows 'Control Panel->System->Device Manager' under 'Ports (COM & LPT)'. Find the A034-B in the list for the USB variant. To change this number, double click the A034-B and select the 'Port Settings' tab. Click the 'Advanced' button and change the port number to the one required.

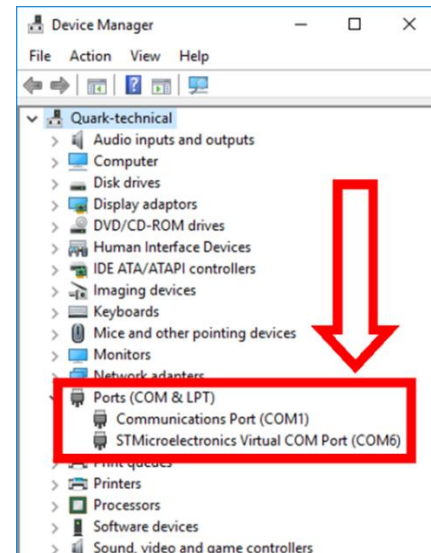

Checking the USB data flow:

If desired, the USB data can always be checked with the configuration tool. To do this, run the configuration tool, connect to A034-B and then click 'Open Port', the input data will be shown on the display field.

(See Configuration section)

3.9. NMEA 0183 output

NMEA 0183 output allows the data inputted, including data transmitted on the NMEA 2000 backbone to be converted into NMEA 0183 format (See list of converted messages above). Data then can be fed to NMEA 0183 interface devices via this port. A034-B monitors NMEA 2000 backbone PGN messages.

Any NMEA 2000 PGNs not required, should be added to the A034-B 'Black list' (See Configuration section) to be filtered out of the data flow. The remaining PGN's will be converted and then fed into a dedicated buffer, sending to NMEA 0183 output.

As NMEA 2000 runs at 250kbps, while the standard NMEA 0183 port runs at 4.8kbps or 38.4kbps. Data overflow cannot be avoided. The only recommendation for solving overflow issues is to prohibit unnecessary messages by filtering (Configuring the Backlist in the Configuration tool) and increasing the baud rate when possible.

4. Configuration (via USB)

The A034-B Configuration tool software can be found on the free CD provided with your product or at <https://www.quark-elec.com/downloads/configuration-tools/>.

The A034-B Windows configuration tool can be used to setup the port routing, sentence filtering, NMEA baud rates, and WiFi settings for the A034-B. It can also be used to monitor and send NMEA sentences through the USB port. The configuration tool must be used on a windows PC (or a Mac using BootCamp or other Windows simulating software) while the A034-B is connected via USB cable. The software cannot access the A034-B via WiFi.

The Configuration tool will not function while another program is using the A034-B. Please close down all applications using the A034-B when using the configuration tool.

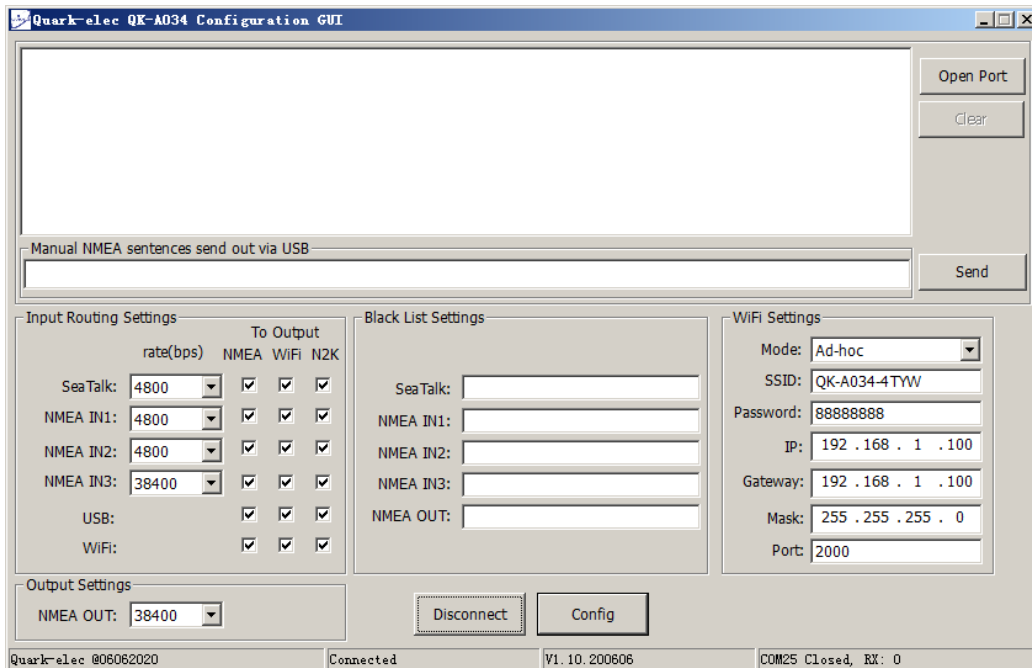

Figure 3: Configuration tool connection

Once open, click **'Connect'**.

When A034-B is connected to a computer (Windows system) and powered up, 'A034connected' will be shown at the centre of the bottom and the software version shows at the bottom right. Press **'Config'** once you have set the Baud rates for the inputs to save them to the A034-B.

Then press the **'Disconnect'** button to safely remove the device from the PC.

Reboot the A034-B to activate the new settings.

4.1. Configuring Baud Rates

NMEA 0183 input baud rates can be setup from dropdown menu.

The A034-B can work with standard NMEA 0183 devices (4800bps), the high-speed NMEA 0183 devices (38400bps) and 9600bps can also be chosen.

Default NMEA baud rates are set to the following default settings:

- Seatalk:4800bps
- NMEA IN 1: 4800bps
- NMEA IN 2: 4800bps
- NMEA IN 3: 38400bps

These can be adjusted as required.

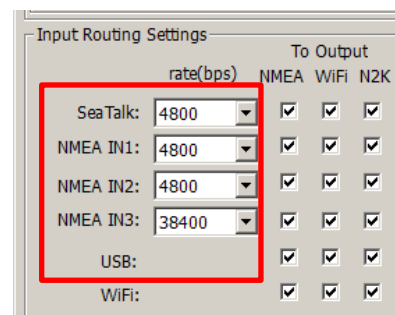

Figure 4: Setup the baud rate

4.2. WiFi - Station mode

WiFi is set to Ad-hoc mode by default. Station mode however, allows your router/access point to handle the data from your device. This data can then be picked up through your router anywhere on your local area network (Similar to plugging the device directly into the router, but using wireless technology). This allows your mobile device to still receive Internet while viewing your marine data.

To begin setup station mode the A034-B should be connected via USB to a computer running Windows (Mac users can use BootCamp).

1. Connect the A034-B to computer via Micro USB B connection
2. Run the Configuration software (having closed any other programs that would access the A034-B)
3. Click 'Connect' and check connection to the A034-B at the bottom of Configuration tool
4. Change working mode to '**Station mode**'
5. Enter your router's **SSID**
6. Enter the **password** for your network
7. Enter the **IP address** assigned to the A034-B, this normally start with 192.168. The third group of digits depends on your router's configuration (commonly 1 or 0). The fourth group must be a unique number between 0 and 255). This number must not be used by any other equipment connected to your router
8. Enter your **router's IP address** in the **Gateway** section. This can usually be found under the router. Leave the other settings as they are
9. Click '**Config**' in the bottom right hand corner and wait 60 seconds. After 60 seconds Click '**Disconnect**'
10. Repower the A034-B and it will now attempt to connect to the router

WiFi Settings	
Mode:	Station
SSID:	QKA034_xer8
Password:	12345678
IP:	192 . 168 . 1 . 100
Gateway:	192 . 168 . 1 . 1
Mask:	255 . 255 . 255 . 0
Port:	2000



In your chart software, set the protocol as '**TCP**', insert the **IP address** you assigned the A034-B and enter the Port number as '**2000**'.

You should now see your marine data in your chart software. If not, check your router's **IP address list** and confirm the **IP address** that your router has assigned the A034-B. Occasionally, a router assigns a different **IP address** to a device than the one you chose to assign it during Configuration. If this is the case, copy the IP address from the router into your chart software.

If the **IP address** in the router's **IP address list** matched the one inputted into the chart software, everything will work in station mode.



If you are not able to view your data in station mode, the likely cause is either the data has been input incorrectly, or the IP address is different in your chart software to that of your router.

4.3. WiFi – Standby/Disable

The WiFi module can be disabled by selecting 'standby' in the WiFi menu

WiFi Settings	
Mode:	Standby

4.4. Filtering

The A034-B features filtering of NMEA 0183 sentences. Each input has a flexible filter that can be configured to pass or block specific sentences from entering the multiplexer. NMEA sentences can be passed or blocked, specified by input. This frees up bandwidth, significantly reducing the possibility of data overflow and resulting loss of data.

Blacklisted input data is filtered out and ignored by the A034-B multiplexer while the remaining desired data is then transmitted to the outputs. As default, all filter lists are empty so all messages are passed through the filters. Filters can be set through the Configuration software.

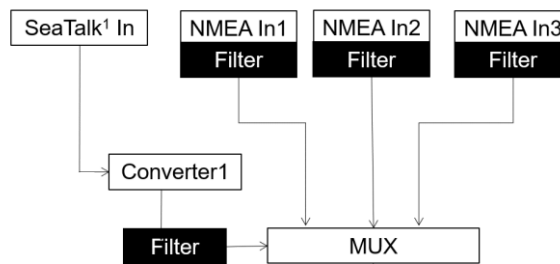

Figure 5: Input Filters Example

Filtering allows the A034-B to reduce the processing data load by disabling these unneeded input sentences. GPS receivers for example often transmit an abundance of sentences every second and can fill much of the available bandwidth of an NMEA 0183 port at 4800bps. By filtering out any unnecessary data the bandwidth is saved for other more crucial device data.

Most chart plotters also have their own sentence filter, however many PC/mobile phone-based applications do not. So, using the black list to filter unnecessary sentences can be helpful.

Filtering also removes potential conflict if two similar NMEA devices provide the same sentence type. Users may choose to enable this data on one input only (filtering), and to transmit to the outputs.

4.4.1. Configuring filters

Each input port's black list can block up to 8 types of sentences. To filter out an unwanted message types from a specific input, enter the details in the corresponding 'Black List' in the Configuration software.

Simply, remove the '\$' or '!' from the 5-digit NMEA talker and sentence identifier and insert separated by commas. For example to block '!AIVDM' and '\$GPAAM' enter 'AIVDM,GPAAM'. If blacklisting SeaTalk data, use the corresponding NMEA message header. (See SeaTalk section for a full list of converted messages).

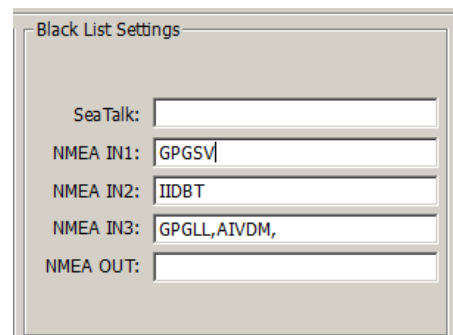

4.4.2. Routing data away from chosen outputs

As a default, all inputs' data (excluding any filtered data) is routed to all outputs (NMEA x2, WiFi and USB). Data can be routed to limit the data flow to only certain output/s.

Simply un-tick the corresponding boxes in the Configuration software.

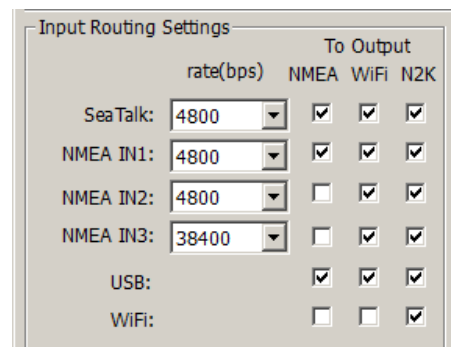

4.5. USB - Monitoring NMEA Messages

Connect A034-B and then click 'Open port', all the sentences will be displayed in the application.

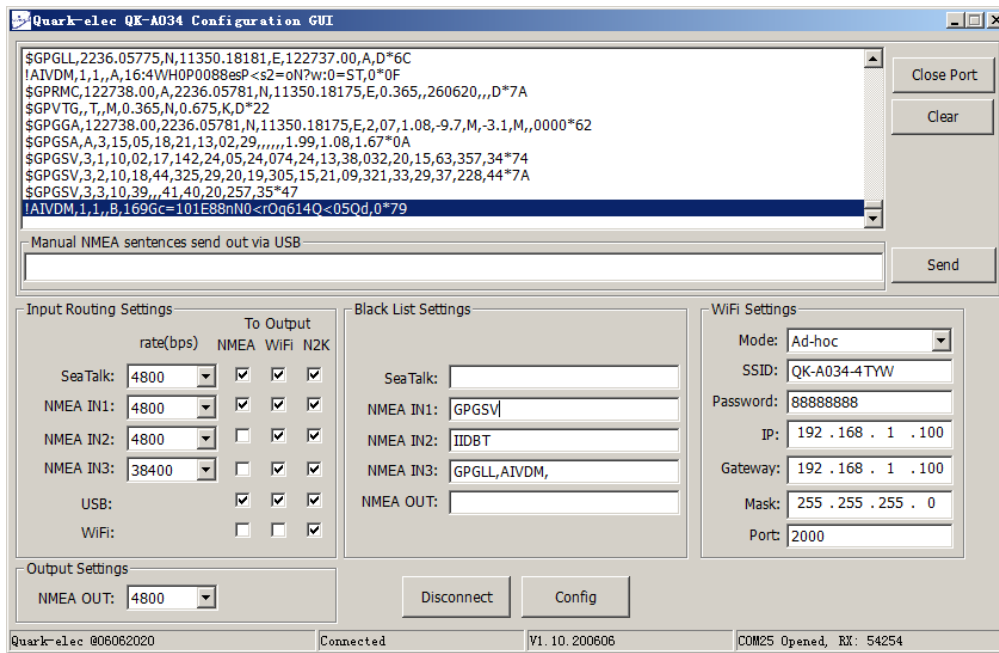

Figure 6: Monitor via USB

5. Upgrading firmware

The current firmware version can be verified through the configuration tool (When connected, the firmware version will show in the bottom of the Configuration software window).

To upgrade the firmware,

1. Power up your A034-B and then connect it to a Windows computer via USB.
2. Run the Configuration software.
3. Ensure the configuration tool is connected to the A034-B, and then click Ctrl+F7.
4. A new Window will pop up with a drive named 'STM32' or similar. Copy the firmware into this drive and wait around 10 seconds to make sure the full file has been copied.
5. Close the window and the Configuration software.
6. Reboot the A034-B, and then the new firmware will be active.

6. Specification

Item	Specification
DC supply	NMEA 2000 network power
Maximum supply current	≤250mA
NMEA data format	ITU/ NMEA 0183 format
NMEA input data rate	4.8k to 38.4kbps, RS-422 galvanically isolated
WiFi mode	Ad-hoc/Station mode on 802.11 b/g/n.
Security	WPA/WPA2
Operating temperature	-25°C to +80°C
Storage temperature	-25°C to +85°C

7. Limited Warranty and Notices

Quark-elec warrants this product to be free from defects in materials and manufacture for one year from the date of purchase. Quark-elec will, at its sole discretion, repair or replace any components that fail in normal use. Such repairs or replacement will be made at no charge to the customer for parts and labour. The customer is, however, responsible for any transportation costs incurred in returning the unit to Quark-Elec. This warranty does not cover failures due to abuse, misuse, accident or unauthorized alteration or repairs. A returns number must be given before any unit is sent back for repair.

The above does not affect the statutory rights of the consumer.

8. Disclaimer

This product is designed to aid navigation and should be used to augment normal navigational procedures and practices. It is the user's responsibility to use this product prudently. Neither Quark-elec, nor their distributors or dealers accept responsibility or liability either to the products user or their estate for any accident, loss, injury or damage whatsoever arising out of the use or of liability to use this product.

Quark- products may be upgraded from time to time and future versions may therefore not correspond exactly with this manual. The manufacturer of this product disclaims any liability for consequences arising from omissions or inaccuracies in this manual and any other documentation provided with this product.

9. Document History

Issue	Date	Changes / Comments
1.0	21-12-2020	Initial release
	28-04-2021	Manual revision

QUARK-ELEC

Quark-elec(UK)

Unit 7, the Quadrant, Newark close
Royston, UK, SG8 5HL

info@quark-elec.com